

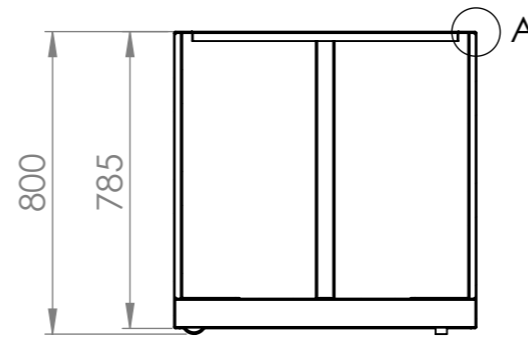

DETAIL A
SCALE 1 : 2

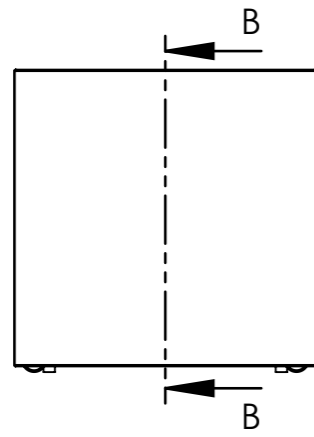

SECTION B-B

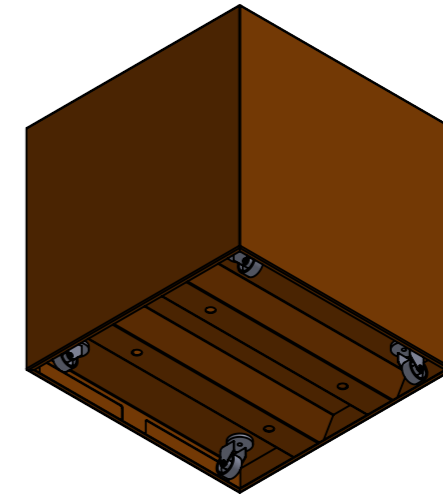
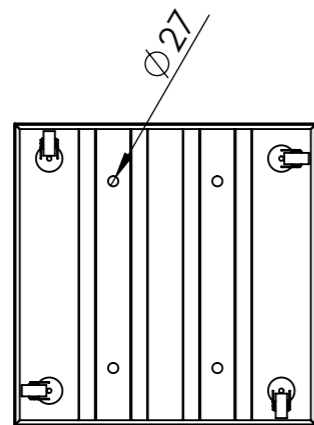
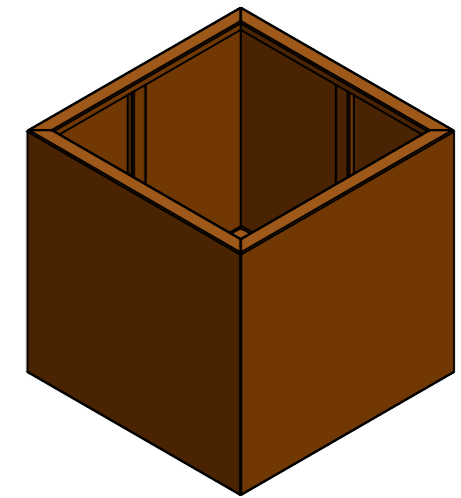

DRAWN	Benny Dijkhuis	DATE	8-11-2019		TITLE:	2mm Corten		
REVISION	Luuk van der Heuvel	DATE	9-12-2020		Drawing:	CAWL 6.1	A3	
		Liessentstraat 4, 5405 AG Uden (NL). † 0031 (0)413 - 27 41 68. e info@adezz.com, i www.adezz.com		Color:	Mass (kg):	61.30	SCALE:1:20	SHEET 1 OF 7